

APPROVAL SPECIFICATIONS

Title. TACT SWITCH

Product Model. KAN0444-0201B1

Customer's Part NO. _____

Customer's Model: _____

Customer's Approval Requested.

Please return this copy as a certification of your approval.

Checked by: _____ **Date:** _____

Approved by: _____ **Date:** _____

APPROVE	REVIEW	POLT
Jack Wu	石兰中	黄崇武



CUSTOMER	CUSTOMER'S P/N	GYE'S P/N	PRODUCT	REVISION
		KAN0444-0201B1	TACT SWITCH	A

1、概述

GENERAL

1.2 适用范围

APPLICATION

此规格书适用于机械式轻触开关的相关要求

This specification is applied to the requirements for TACTILE SWITCH (MECHANICAL CONTACT)

1.3 工作温度范围

Operating Temperature Range

-10℃~70℃(在标准大气压、标准湿度条件下)

-10℃~70℃ (Normal humidity, normal air pressure)

1.4 贮藏温度范围

Storage Temperature Range

-25℃~85℃(在标准大气压、标准湿度条件下)

-25℃~85℃ (Normal humidity, normal air pressure)

1.5 测试条件

Test Conditions

在没有其它特定的条件下，应该在以下的条件下进行测试和测量：

Unless otherwise specified, tests and measurement shall be made in the following standard conditions:

常温.....5℃~35℃

Normal temperature.....5℃~35℃

标准湿度.....相对湿度 25%~85%

Normal humidity.....relative humidity 25%~85%

标准大气压.....86KPa~106Kpa

Normal air pressure.....86Kpa~106Kpa

在制造过程中，测试和测量应该在以下的条件下进行：

If any doubt arise from the judgment, tests shall be conducted at the following conditions:

温度.....20℃±2℃

Temperature.....20℃±2℃

相对湿度.....65%±5%

Relative humidity.....65%±5%

环境气压.....86KPa~106Kpa

Air pressure.....86KPa~106Kpa



CUSTOMER	CUSTOMER'S P/N	GYE'S P/N	PRODUCT	REVISION
		KAN0444-0201B1	TACT SWITCH	A

2、 详细说明**Detailed specification**

2.1 外观：应无影响、降低产品性能的缺陷；

Appearance: There should be no defects that affect the serviceability of product.

2.2 结构尺寸和安装尺寸：应符合装配图要求；

Style and dimension: shall conform to the assemble drawings.

2.3 操作形式：有触觉反应的操作

Type of actuating: Tactile feedback.

2.4 开关结构：单回路单输出(具体的触点结构在装配图中已绘出)；

Contact arrangement: 1 pole, 1 throw

(Details of contact arrangement are given in the assembly drawings.)

2.5 开关工作额定值：DC 12V, 50mA (最大值)

Ratings: 12V DC, 50mA (Max)

3. 电气性能：**ELECTRICAL SPECIFICATION**

项 目 ITEM		试 验 条 件 TEST CONDITIONS	要 求 REQUIREMENTS
1	接触电阻 Contact Resistance	在以 5V 10mA 的直流电源或不低于 1KHz 的交流电源的电路中，以一个等于 2 倍接力的静负荷施加于手柄中心 Applying a static load of 2 times operating force to the center of the stem, measurements shall be made by 5V DC 10mA or more than 1KHZ AC small-current contact resistance meter.	$\leq 100m\Omega$
2	绝缘电阻 Insulation Resistance	在端子之间施加 DC 100V /1min 的条件下, 测量端子之间底座、盖板的电阻值 Measurement shall be made following application of 100V DC potential, across terminals, and across terminals and cover, for one minute.	$\geq 50M\Omega$
3	介质耐压 Dielectric voltage proof	在端子之间施加 250V AC (50HZ 或 60HZ) /1min 250V AC (50HZ or 60HZ) shall be applied across terminals, for one minute.	无击穿、无飞弧 There should be no breakdown and flashover



CUSTOMER		CUSTOMER'S P/N	GYE'S P/N	PRODUCT	REVISION	
			KAN0444-0201B1	TACT SWITCH	A	
项目 ITEM	试验条件 TEST CONDITIONS			要求 REQUIREMENTS		
4	触点抖动 Bounce	<p>按照正常使用时的力度轻按手柄中心（每秒 3~4 次），在导通和断开过程中测试开关抖动</p> <p>Lightly striking the center of the stem at a rate encountered in normal use (3 to 4 times per second), and bounce shall be tested at "ON" and "OFF"</p> <p>开关 Switch</p> <p>示波器 Oscilloscope</p> <p>“导通” “ON”</p> <p>“断开” “OFF”</p>			<p>ON-10 msec.max OFF-10 msec.max</p>	
4. 机械性能： MECHANICAL SPECIFICATION						
1	按力 Operating Force	<p>开关垂直于操作方向放置，在开关驱动件顶端中心逐渐施力，测量开关导通所需的最大力度。</p> <p>Placing the switch such that the direction of switch operation is vertical and then gradually increasing the load applied to the center of the stem, the maximum load required for the switch to come to a stop shall be measured.</p>			160gf±30gf	
2	最大行程 Full Travel	<p>开关垂直于操作方向放置，以一个等于 2 倍按力的静负荷施加在开关驱动件顶端中心，测量顶端移动的距离。</p> <p>Placing the switch such that the direction of switch operation is vertical and then applying static load of 2times operating force to the center of the stem; the travel distance for the switch to come to a stop shall be measured.</p>			0.15±0.1mm	



CUSTOMER		CUSTOMER'S P/N	GYE'S P/N	PRODUCT	REVISION
			KAN0444-0201B1	TACT SWITCH	A
项目 ITEM		试验条件 TEST CONDITIONS			要求 REQUIREMENTS
3	回弹力 Return Force	<p>开关垂直于操作方向放置，在开关驱动件顶端中心下降至全行程后，测量顶端向自由位置转换的力度。</p> <p>The sample switch is installed such that the direction of switch operation is vertical and upon depressing the stem in its center to the whole travel distance, the force of the stem to return to its free position shall be measured.</p>			40gf MIN
4	停止强度 Stop Strength	<p>开关垂直于操作方向放置，从操作方向向驱动件施加 20N 的静负荷持续 1min。</p> <p>Placing the switch such that the direction of switch operation is vertical, and then a static load of 30N shall be applied in the direction of stem operation for a period of 1 min.</p>			<p>无机械和电气损坏</p> <p>There shall be no sign of damage mechanically and electrically.</p>
5	可焊性 Solderability	<p>在以下设定条件下进行测量： Measurements shall be made following the test set forth below:</p> <p>(1) 焊接温度:245±5℃ Solder temperature : 245±5℃</p> <p>(2) 浸入时间:2s±0.5s Immersion time: 2s±0.5s</p> <p>对于其它步骤参考《GB 5095.6—86》试验 12a The other steps please refer to 《GB 5095.6-86》 TEST 12a</p>			<p>除边缘外涂层应均匀覆盖 90%以上</p> <p>Except for the edge, the coating should cover a minimum 90%</p>



APPROVAL SPECIFICATIONS

CUSTOMER	CUSTOMER'S P/N	GYE'S P/N	PRODUCT	REVISION
		KAN0444-0201B1	TACT SWITCH	A
项目 ITEM	试验条件 TEST CONDITIONS		要求 REQUIREMENTS	

5、极限电气性能： ENVIRONMENTAL SPECIFICATION

1	低温测试 Resistance to low temperature	<p>样品应按照以下实验条件进行测试，实验后样品应放在常温及标准湿度的环境中 1 小时后做性能测试： Following the test set forth below the sample shall be left in normal temperature and humidity conditions for 1 h before measurements are made:</p> <p>(1) 温度：-25±2℃ Temperature : -25±2℃</p> <p>(2) 时间：96h Time: 96h</p>	<p>接触电阻：≤500mΩ Contact resistance: ≤500mΩ 项目 3,4.1,4.2,4.3 Item 3,4.1,4.2,4.3</p>												
2	高温测试 Heat resistance	<p>样品应按照以下实验条件进行测试，实验后样品应放在常温及标准湿度的环境中 1 小时后做性能测试： Following the test set forth below the sample shall be left in normal temperature and humidity conditions for 1 h before measurements are made:</p> <p>(1) 温度：85±2℃ temperature:85±2℃</p> <p>(2) 时间：96h time: 96h</p>	<p>接触电阻：≤500mΩ Contact resistance: ≤500mΩ 项目 3,4.1,4.2,4.3 Item 3,4.1,4.2,4.3</p>												
3	温度周期性测试 Change of temperature	<p>根据下面的测试要求进行 5 次循环的温度周期性测试，实验后样品应放在常温及标准湿度的环境中 1 小时后做性能测试。测试期间样品应保持干燥。 After 5 cycles of following conditions, the sample shall be allowed to stand under normal temperature and humidity conditions for 1 h. and measurements shall be made. During the test water drops shall be removed.</p> <table border="1"> <thead> <tr> <th></th> <th>Temperature</th> <th>Time</th> </tr> </thead> <tbody> <tr> <td rowspan="4">1cycle</td> <td>-10±2℃</td> <td>2(hour)</td> </tr> <tr> <td>-10~65℃</td> <td>1</td> </tr> <tr> <td>65±2℃</td> <td>2</td> </tr> <tr> <td>65~-10℃</td> <td>1</td> </tr> </tbody> </table>		Temperature	Time	1cycle	-10±2℃	2(hour)	-10~65℃	1	65±2℃	2	65~-10℃	1	<p>接触电阻：≤500mΩ Contact resistance: ≤500mΩ 项目 3,4.1,4.2,4.3 Item 3,4.1,4.2,4.3</p>
	Temperature	Time													
1cycle	-10±2℃	2(hour)													
	-10~65℃	1													
	65±2℃	2													
	65~-10℃	1													



APPROVAL SPECIFICATIONS

CUSTOMER		CUSTOMER'S P/N	GYE'S P/N	PRODUCT	REVISION
			KAN0444-0201B1	TACT SWITCH	A
项目 ITEM		试验条件 TEST CONDITIONS			要求 REQUIREMENTS
4	湿温测试 Moisture resistance	<p>样品应按照以下实验条件进行测试，实验后样品应放在常温及标准湿度的环境中 1 小时后做性能测试： Following the test set forth below the sample shall be left in normal temperature and humidity conditions for 1 h before measurements are made:</p> <p>(1) 温度：85±2℃ temperature: 85±2℃</p> <p>(2) 相对湿度：85% relative humidity:85%</p> <p>(3) 时间：96h time: 96h</p>			<p>接触电阻：≤500mΩ Contact resistance: ≤500mΩ</p> <p>绝缘电阻：≥ 50MΩ Insulation Resistance: ≥ 50MΩ</p> <p>项目 3,4.1,4.2,4.3 Item 3,4.1,4.2,4.3</p>
5	硫化试验 Sulfuration resistance	<p>样品应按照以下实验条件进行测试，实验后样品应放在常温及标准湿度的环境中 1 小时后做性能测试： Following the test set forth below the sample shall be left in normal temperature and humidity conditions for 1 h before measurements are made:</p> <p>(1) H₂S 气体浓度：3ppm±1ppm H₂S gas concentration: 3ppm±1ppm</p> <p>(2) 时间：72h Time: 72h</p> <p>(3) 温度：40±2℃ (90~95%RH) Temperature: 40±2℃ (90~95%RH)</p>			<p>接触电阻：≤500mΩ Contact resistance: ≤500mΩ</p> <p>项目 3,4.1,4.2,4.3 Item 3,4.1,4.2,4.3</p>
6	盐雾试验 Salt Mist	<p>在以下设定条件下进行测量： The switch shall be checked after following test:</p> <p>(1) 温度：35℃±2℃ temperature: 35℃±2℃</p> <p>(2) 盐溶液浓度：5±1% (质量百分比) salt solution : 5±1%(solids by mass)</p> <p>(3) 时间：12h±1h Time: 12h±1 hour</p> <p>实验后的盐沉积物后水冲掉 After test, salt deposit shall be removed by running water.</p>			<p>金属件上没有腐蚀斑点 No remarkable corrosion shall be recognized in metal part.</p>



CUSTOMER	CUSTOMER'S P/N	GYE'S P/N	PRODUCT	REVISION
		KAN0444-0201B1	TACT SWITCH	A

6、极限机械性能：

ENDURANCE SPECIFICATION

项目 ITEM	试验条件 TEST CONDITIONS	要求 REQUIREMENTS
1 工作寿命 Operation life	<p>根据下面的测试要求进行测试： Measurement shall be made following the test set forth below:</p> <p>(1) DC 12V, 50 mA 带负载 DC 12V, 50 mA resistive load</p> <p>(1) 按动速率：1-2 次/秒 Rate of operation: 1-2 times/s</p> <p>(3) 按力：300 克</p> <p>(4) Operating Force: 300g</p> <p>(5) 寿命：100, 000 次 Life : 100,000 cycles</p>	<p>接触电阻 $\leq 500\text{m}\Omega$ Contact resistance $\leq 500\text{m}\Omega$</p> <p>绝缘电阻：$\geq 50\text{M}\Omega$ Insulation Resistance: $\geq 50\text{M}\Omega$</p> <p>按力：初值的 $\pm 30\%$ Operating Force: initial value $\pm 30\%$</p> <p>项目 3,4.1,4.2,4.3 Item 3,4.1,4.2,4.3</p>
2 振动 Vibration	<p>根据以下给定条件进行测试： Measurement shall be made following the test set forth below:</p> <p>(1) 振动频率范围：10~55~10Hz Vibration frequency range: 10 to 55 to 10Hz</p> <p>(2) 振幅（峰—峰）：1.5mm Amplitude: 1.5mm</p> <p>(3) 振动方向：包括手柄行程方向在内的三个相互垂直的方向 Direction of vibration: Three mutually perpendicular direction including the direction of stem travel</p> <p>(4) 测试时间：每次 2hours . Duration: Each 2hours.</p>	<p>项目 3,4.1,4.2,4.3 Item 3,4.1,4.2,4.3</p>
3 冲击 Shock	<p>开关应在实验后测量 Switch shall be measured after following test.</p> <p>1.安装方法：正常安装 Mounting method: Normal mounting method</p> <p>2.加速 490 m/s² (50G) Acceleration:490 m/s² (50 G)</p> <p>3.持续时间：11 ms Duration: 11 ms</p> <p>4.测试方向：6 个方向 Test direction: 6 directions</p> <p>5.冲击次数：每个方向 3 次（18 次计） Number of shocks: 3 times per direction (18 times in total)</p>	<p>项目 3,4.1,4.2,4.3 Item 3,4.1,4.2,4.3</p>

7. 焊接条件：

SOLDERING CONDITIONS:

7.1 手工焊接 Hand soldering	<p>请按以下条件进行焊接：</p> <p>(1) 焊锡温度：$\leq 350^{\circ}\text{C}$ Soldering temperature: 350°C Max.</p> <p>(2) 连续焊接时间：$\leq 3\text{ s}$ Continuous soldering time: 3 s Max.</p>
-------------------------------	--------------------------------------------------------------------------------------------------------------------------------------------------------------------------------------------------------------------------



CUSTOMER	CUSTOMER'S P/N	HUAHUI' S P/N	PRODUCT	REVISION
		KAN0444-0201B1	TACT SWITCH	A

项目 ITEM	推荐条件 Recommended conditions
------------	--------------------------------

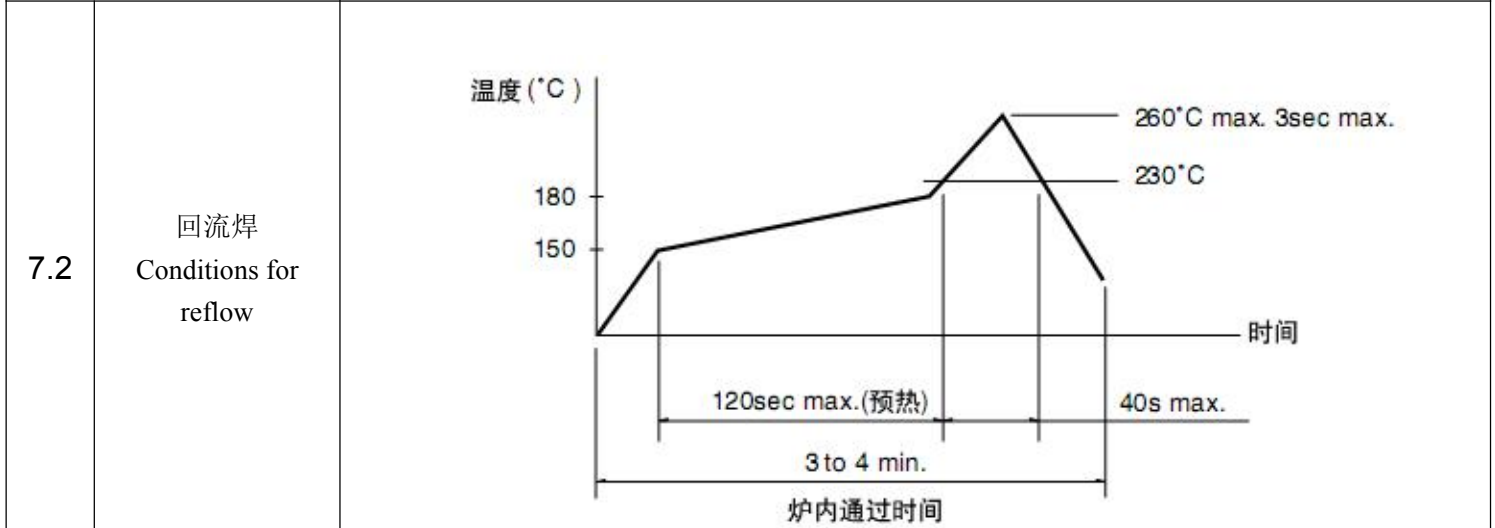

说明:

- 1.1 开关浸焊后, 注意不要用溶剂清洗。
After switches were soldered, please be careful not to clean switches with solvent.
- 1.2 在使用烙铁的情况下, 焊锡温度应在 380°C 以下、3 秒以内。
In the case of using soldering iron, soldering conditions shall be 380°C max and 3 sec.max.
- 1.3 浸焊后, 注意不要在顶部施加负荷。
Right after switches were soldered; please be careful not to load to on the knobs of switches.

2 设计中应注意的事项(Design instructions):

- 2.1 印刷基板的安装孔尺寸参见产品图。
Follow recommended P.W.B. piercing plan in outside drawing page.

3 注意点(Note):

- 3.1 注意不要施加超负荷的压力或晃动开关
Please be cautions not to give excessive static load or shock to switches.
- 3.2 开关浸焊后, 印刷基板注意不要叠放。
Please be careful not to pile up P.W.B. after switches were soldered
- 3.3 保管时尤其应注意避开高湿高温和有腐蚀性气体的环境。如需要长时间保存, 请不要打开包装箱。
Preservation under high temperature and high high humidity or corrosive gas should be avoided Especially . When you need to preserve for a long period ,do not open the carton .



GANGYUAN

APPROVAL SPECIFICATIONS

CUSTOMER	CUSTOMER'S P/N	GYE'S P/N	PRODUCT	REVISION
		KAN0444-0201B1	TACT SWITCH	A

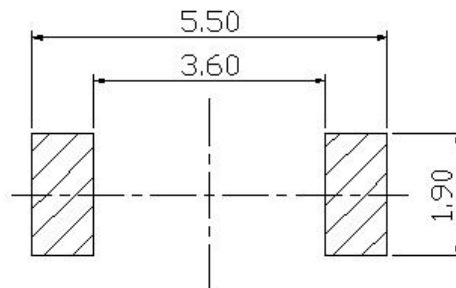
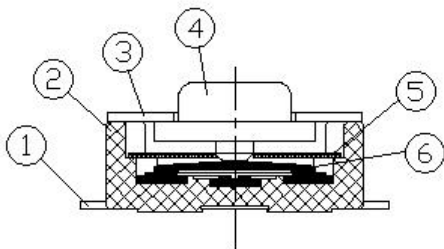
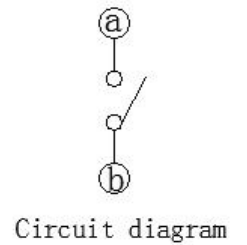
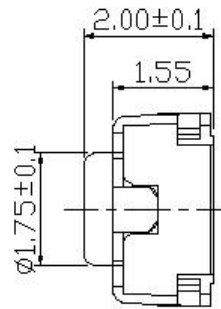
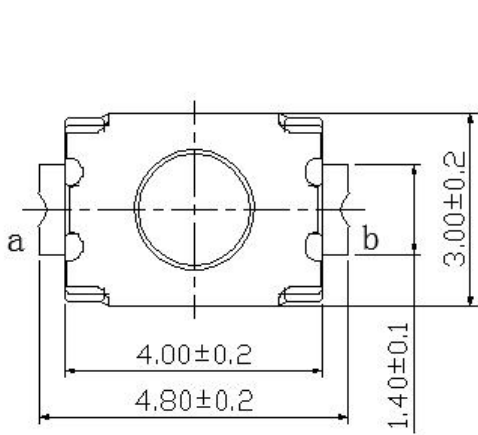

Printed Circuit board dimensions

General tolerance: $\pm 0.1\text{mm}$

NO.	NAME	MATERIAL	QTY	FINISHING
1	端子	C5191	1	镀银
2	底座	LCP	1	黑色
3	上盖	SUS	1	
4	按钮	PA9T	1	黑色
5	贴膜	金手指	1	黄色
6	弹片	SUS	2	单面覆银

ITEM	W	AO	BO	KO	P	F	E	D	PO	T	13°
DIM	12	3.5	5.3	2.8	8	5.5	1.75	1.5	4	0.3	元件/盘
TOL	±0.3	±0.1	±0.1	±0.1	±0.1	±0.1	±0.1	+0.10 -0.00	±0.1	±0.5	3000PCS

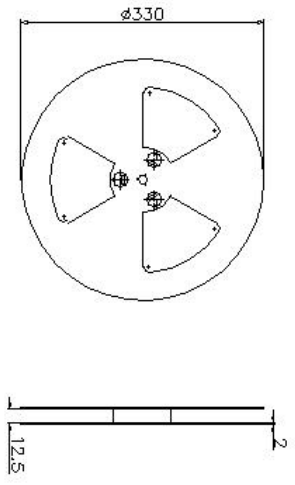
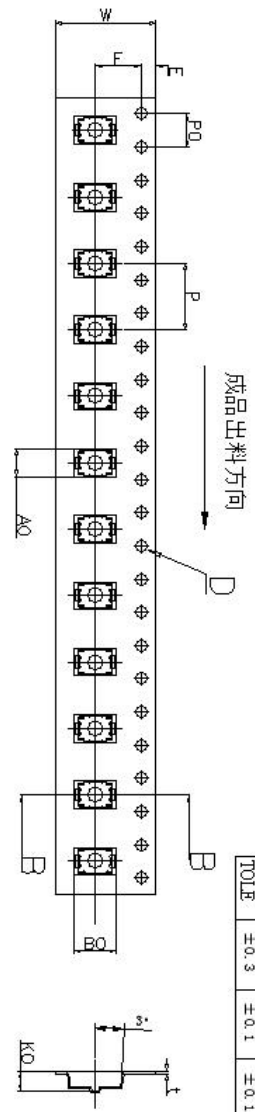

ITEM NO. PCS
 QTY: KG
 N. W: KG
 G. W: KG
 MEAS: 44*35*35CM

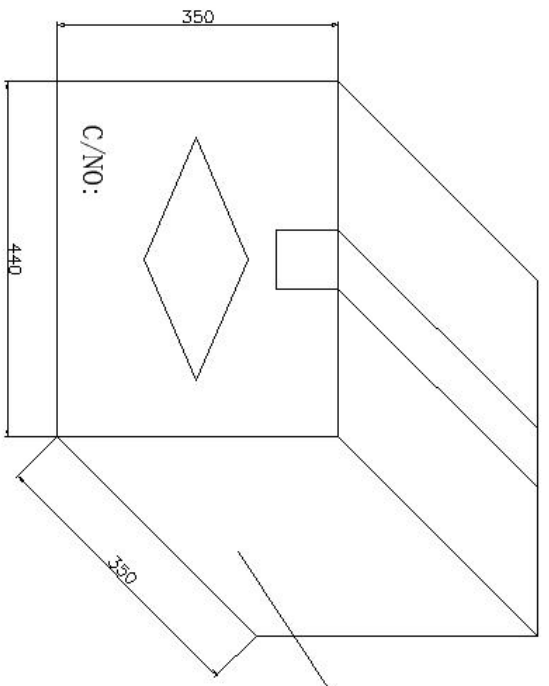

Outside box 75, 000pcs
 (25 reels)

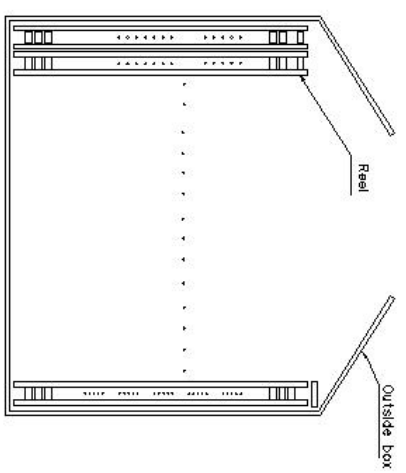

深圳市港源微键技术有限公司

REV.	修改	审核	日期	公差
1	CHANGE	APPRO.	DATE	一般公差

DESIGN	CHECK	APPRO.	MATERIAL	NAME	TYPE	DRAWING NO.	SCALE	UNIT	REV.	REV.	REV.	ENG. DWG
				载带	TYPE NO.	ENH44-08-1258-020	1:1	mm	A0			

1 2 3 4 5 6